Introduction

The CER Series LTE ceramic chip antenna is a monopole antenna, so the PCB implementation is critical to its performance. The antenna is tested on a 120mm test board with a 107mm ground plane. Many applications need to use a smaller ground plane due to product size limits or other constraints. This application note shows the change in antenna performance with different size ground planes.

Antenna Performance

The antenna is specified and tested in production on a 120mm test board. All of the specifications and radiation patterns in the antenna's data sheet are taken on this board. The figures below show the antenna's performance on 120mm, 100mm, 80mm and 60mm test boards.

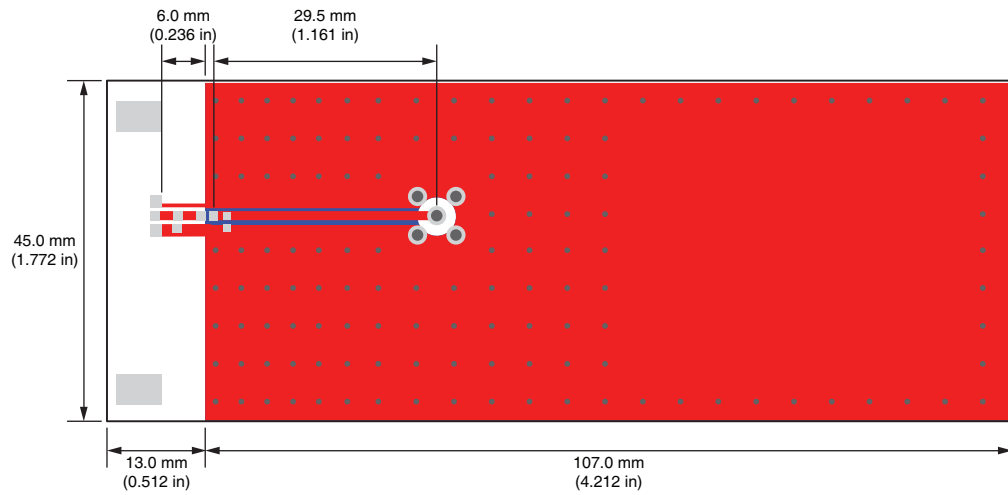

Figure 1: 120mm Test Board

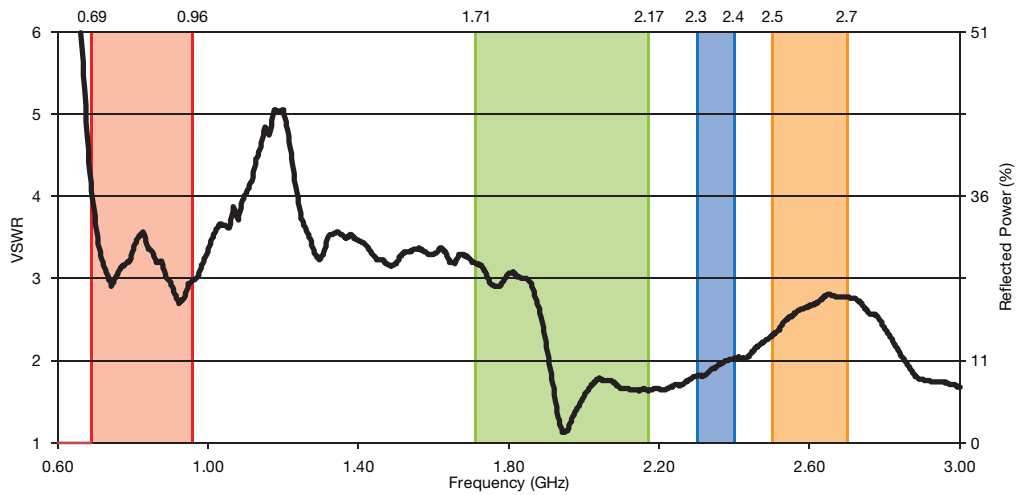

Figure 2: VSWR on 120mm Test Board

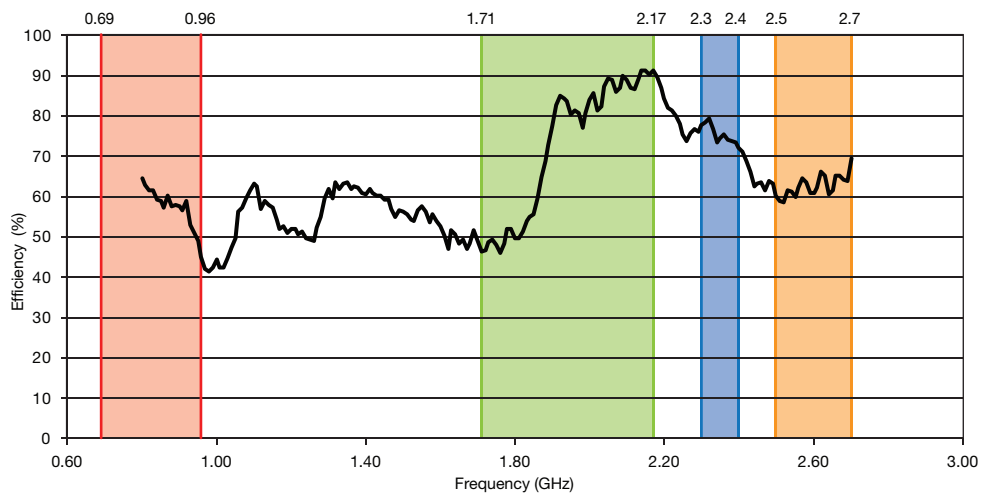

Figure 3: Efficiency on 120mm Test Board

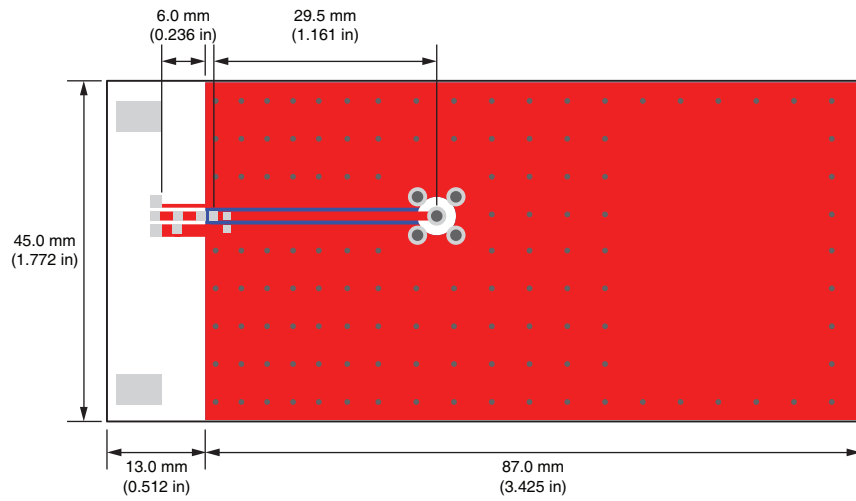

Figure 4: 100mm Test Board

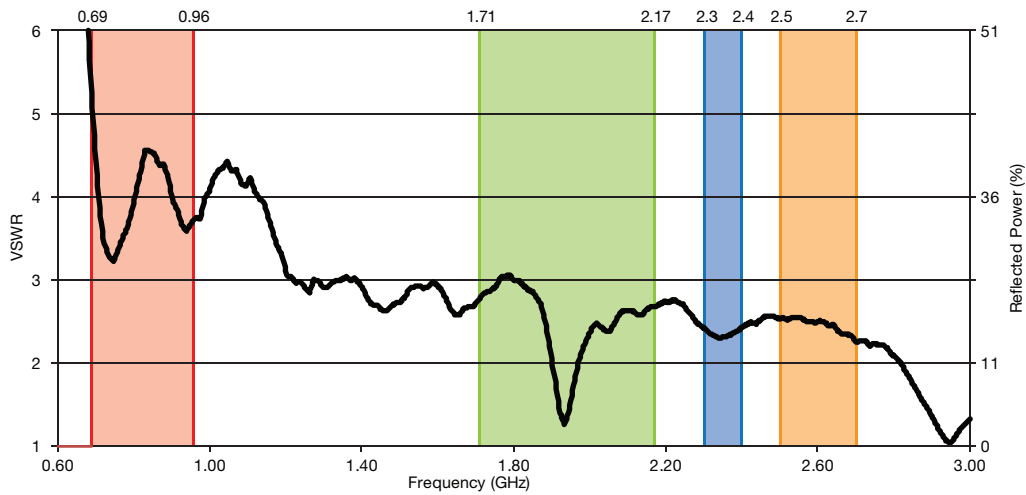

Figure 5: VSWR on 100mm Test Board

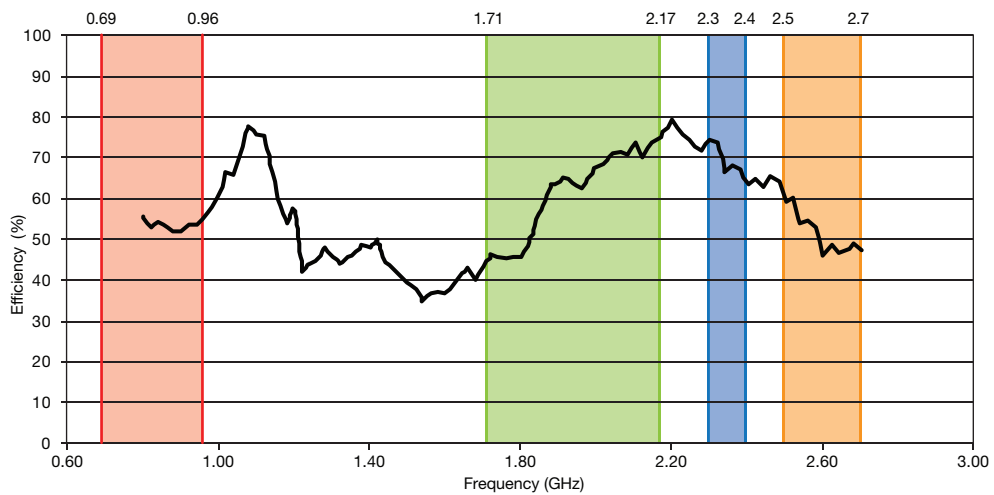

Figure 6: Efficiency on 100mm Test Board

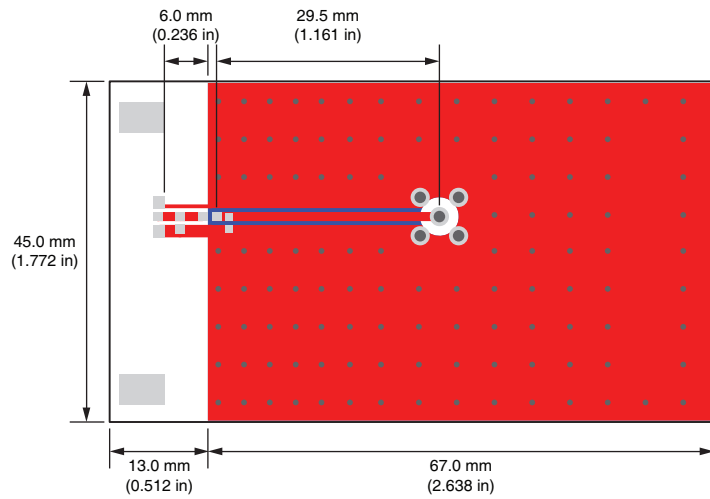

Figure 7: 80mm Test Board

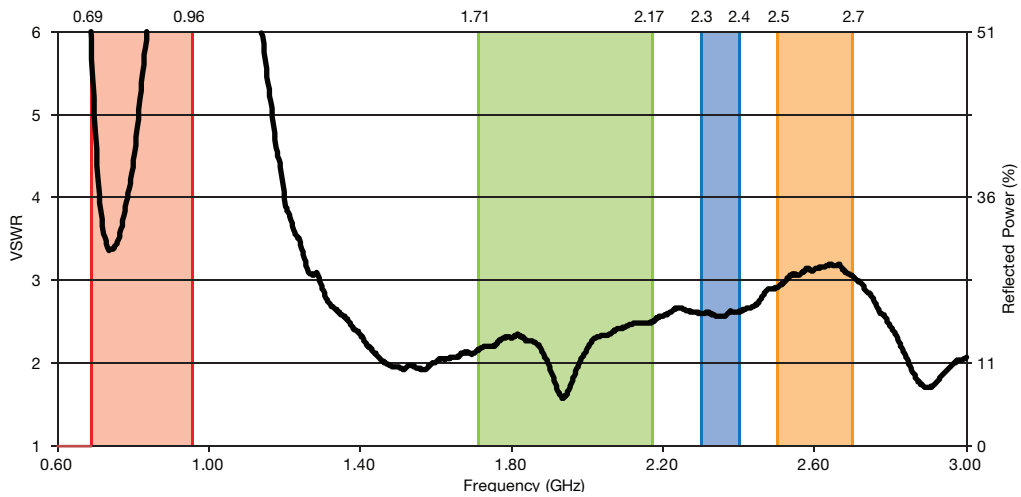

Figure 8: VSWR on 80mm Test Board

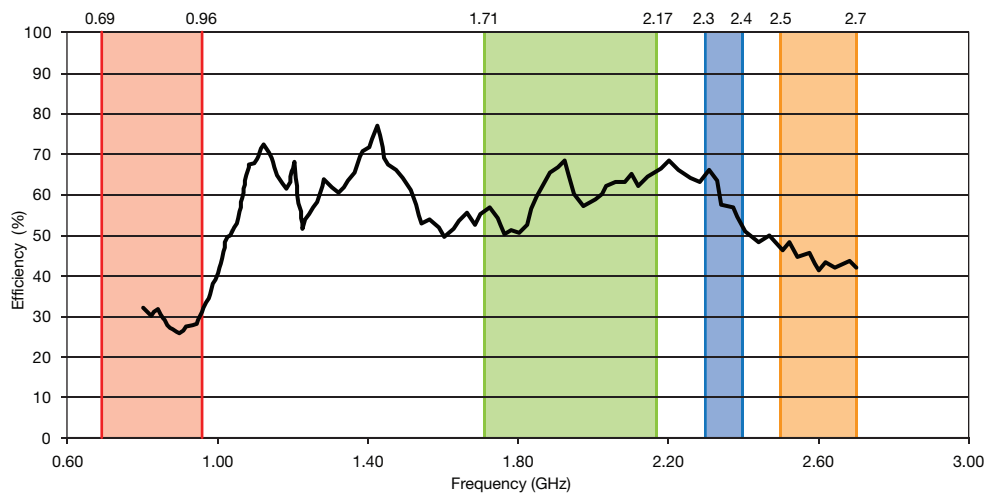

Figure 9: Efficiency on 80mm Test Board

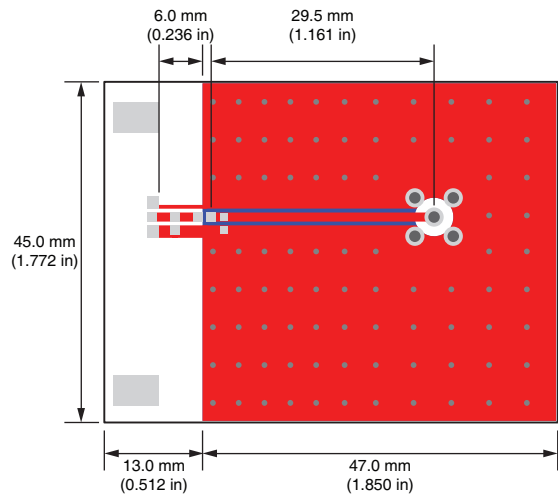

Figure 10: 60mm Test Board

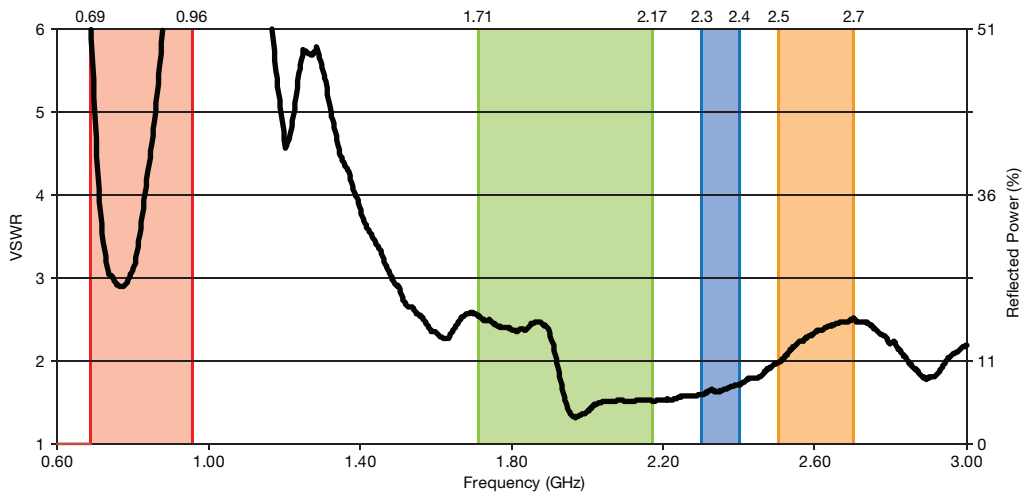

Figure 11: VSWR on 60mm Test Board

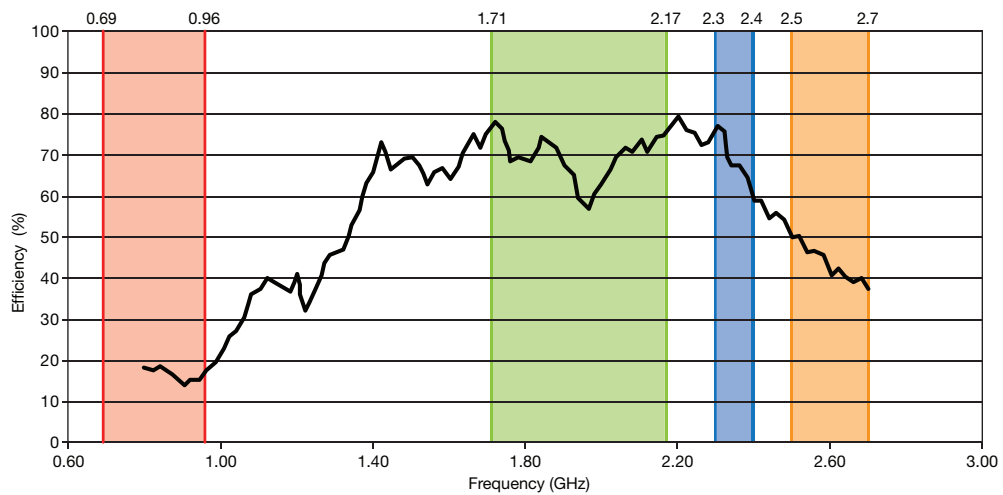

Figure 12: Efficiency on 60mm Test Board

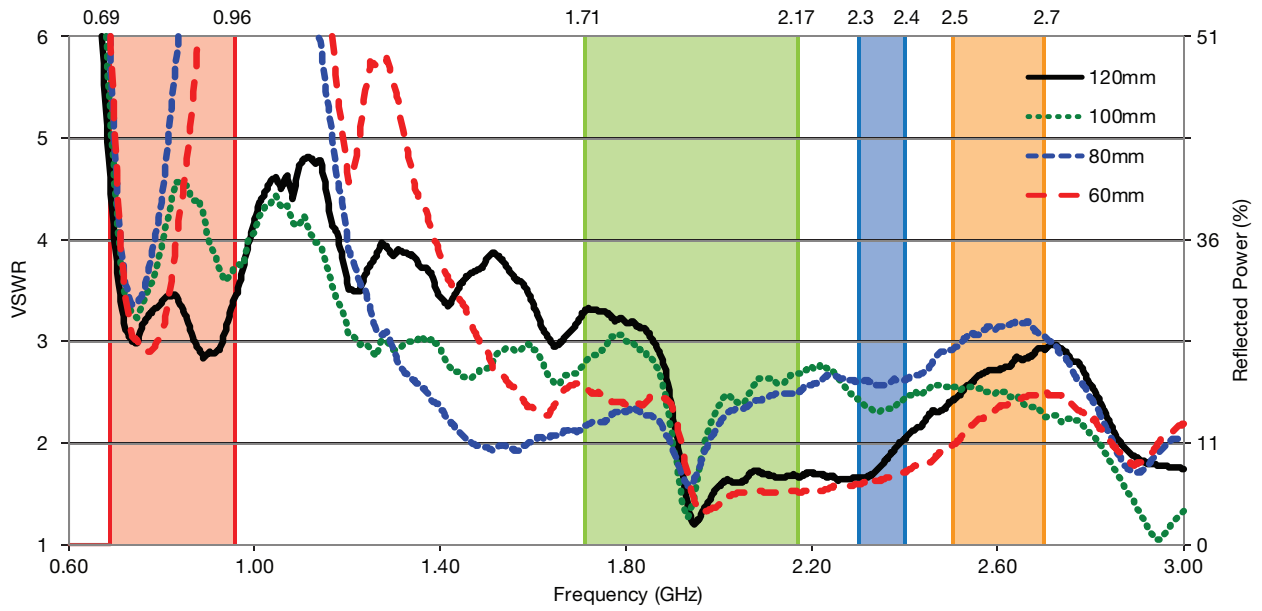

Figure 13: VSWR on Different Test Boards

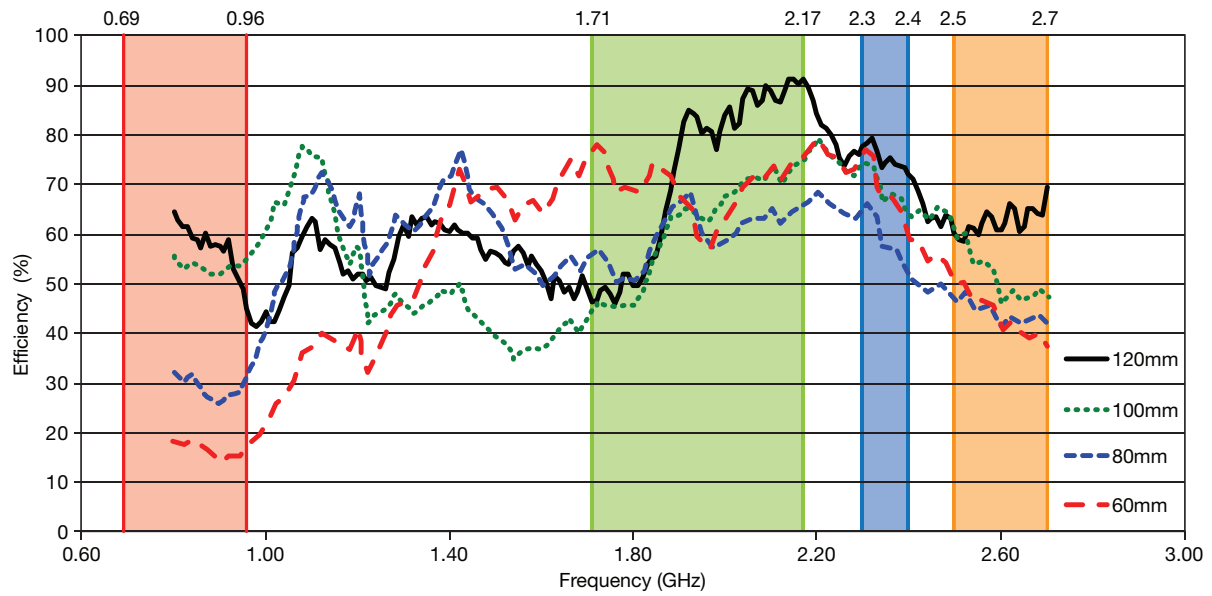

Figure 14: Efficiency on Different Test Boards

As can be seen from the data, the performance can vary widely with the ground plane size. It is possible to adjust the performance using a matching network. This can enable the integrator to be able to optimize performance in a specific band or to level performance across all of the bands. Figure 15 shows two types of matching networks, a basic and a full network.

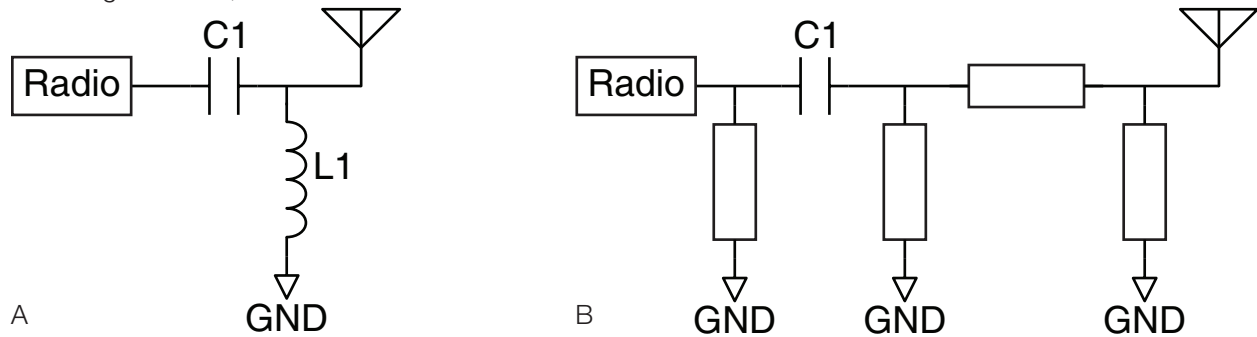
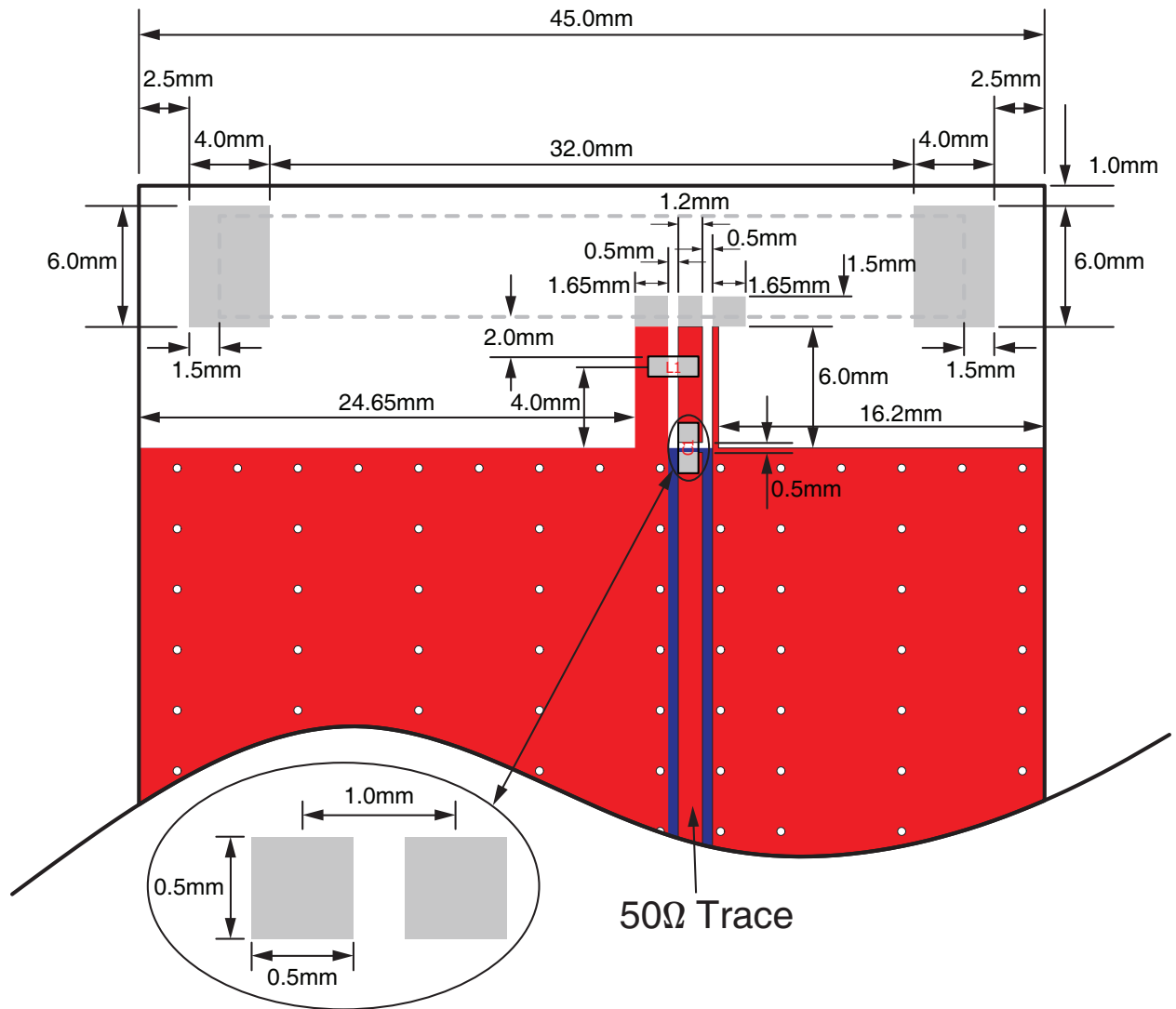

Figure 15: Basic (A) and Full (B) Matching Networks

The basic network is the minimum number of components that can be used to adjust the antenna's response. The full network uses more components, but gives much more control over the antenna's response.

Figure 16 shows the layout with the basic matching network. This is implemented on the CER Series antenna evaluation board. A layout with the full matching network is shown in Figure 17.

The values of the matching components will need to be determined experimentally on the final product board. There are many variables that play into the antenna's final performance, so it is very difficult to predict what it will do on any specific design. It is best to design in the matching network, see what the antenna does on the prototype and then dial the performance in with the network components.



Matching Network		
Designator	Size	Description
L1	0402	6.8nH Inductor (Taiyo Yuden HK10056N8S-T)
C1	0402	3pF Capacitor (Murata Electronics GRM1555C1H3R0CA01D)

Figure 16: Layout with the Basic Matching Network

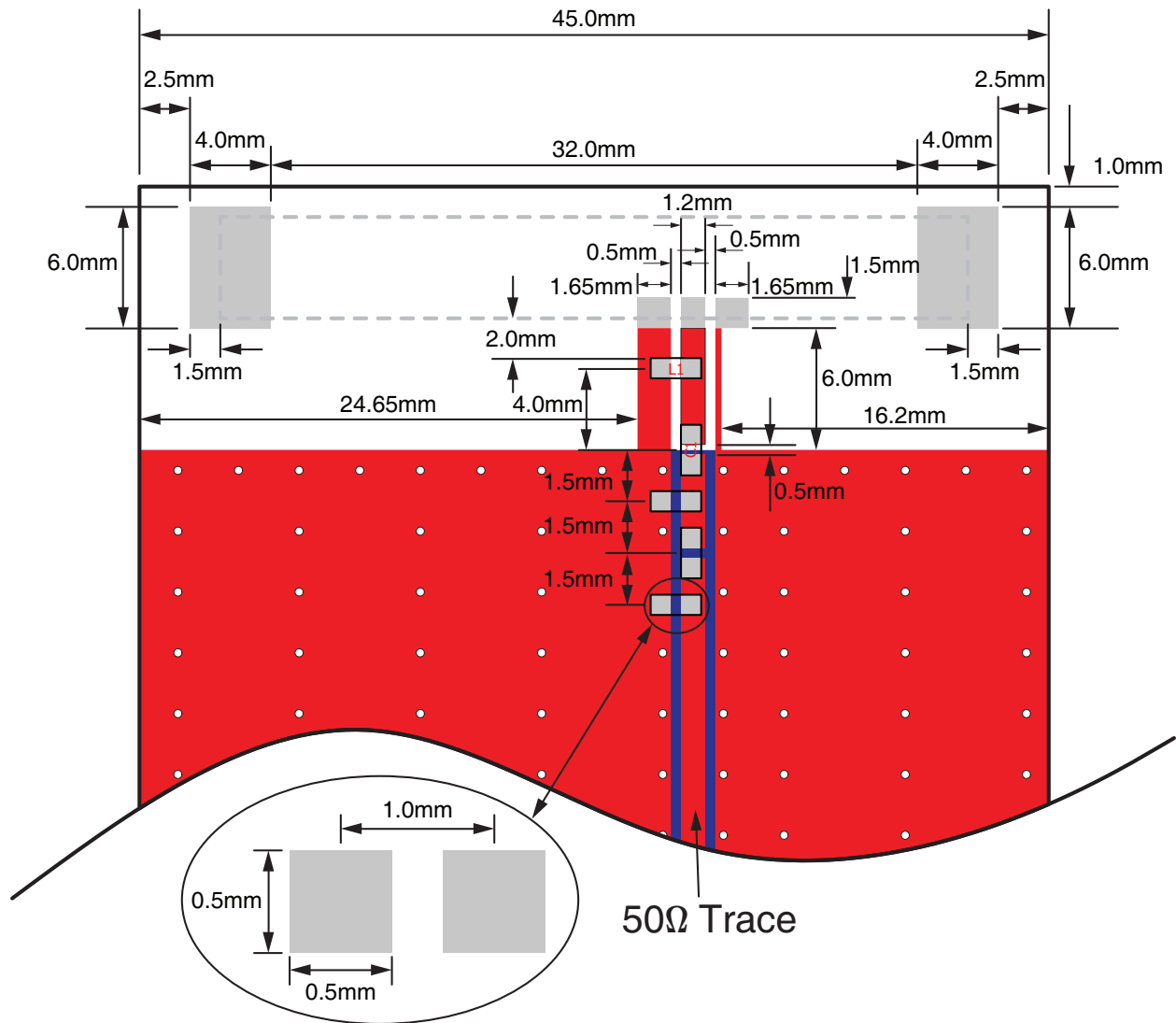

Figure 17: Layout with the Full Matching Network