

## Splatch® SP610 Ground Plane Optimization

The Linx Technologies Splatch® SP610 embedded LTE, LTE-M, NB-IoT antenna is a 1/4-wave monopole antenna which requires a ground plane on the printed circuit board (PCB) to which it is mounted. Linx recommends a 102 mm x 45 mm or larger ground plane, but other size ground planes may be used with proper design consideration as described in this application note. Please refer to the SP610 datasheet for other design requirements for the SP610 or contact Linx for a free design review to help optimize solution performance.

### Application Overview

This application note presents SP610 performance results for the recommended minimum 102 mm x 45 mm ground plane and simulated performance for smaller ground plane sizes. All ground planes specified in this application note are 45 mm wide based on the 40 mm length of the SP610 antenna. Wider ground planes are permissible.

Simulation is also provided for a 120 mm x 45 mm ground plane to enable direct comparison to competing antennas which tend to be marketed using larger ground planes than are typically used by customers because it “enhances” performance data.

Antenna matching networks are defined for each ground plane size to be used as a starting point for designing small ground plane SP610 solutions. As with all embedded antenna solutions, the required matching network to optimize performance will vary depending on the actual components and enclosure used in the design as well as the surroundings in which the antenna operates. Please contact Linx for a complimentary design review to help optimize matching.

The ground plane sizes and simulated matching networks presented are provided in Figure 1.

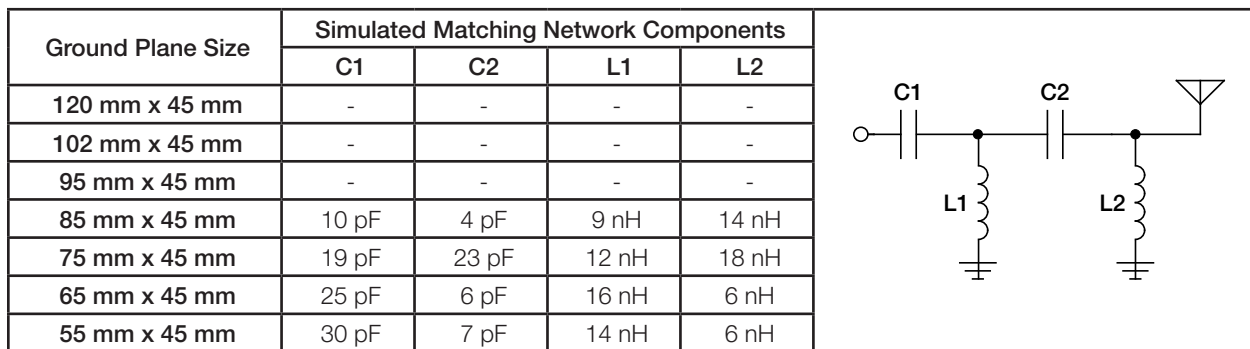

Figure 1. Summary of Ground Plane Sizes and Matching Networks Presented

### Ground Plane Requirements

Shortening the ground plane reduces the bandwidth of the antenna at lower frequencies. This is most noticeable in the VSWR performance. The use of matching networks allows VSWR to be optimized for the ground plane conditions but cannot completely account for a ground plane that is too small for target frequencies.

In theory, the minimum ground plane size for any 1/4-wave monopole antenna is determined by its guided 1/4 wavelength,  $\lambda_g/4$ . This guided wavelength will be based on the 1/4 wavelength of the lowest frequency supported by the antenna, but will be restricted – lengthened – by the material through which the antenna

signal propagates. For the SP610, the guided wavelength is defined by the FR4 material from which the antenna is constructed and should be greater than or equal to 90 mm. In practice it is also important to provide some margin greater than the guided wavelength for the ground plane size to account for electromagnetic fringing effects at the PCB edges.

There is no limitation on how large a ground plane may be in support of a monopole antenna and a larger ground plane will improve antenna performance.

## Comparing Antenna Performance

When comparing performance of the SP610 against other antennas or across varying lengths of ground plane it is important to review more than just VSWR (See the SP610 datasheet and definitions provided at the end of this application note). The peak gain and efficiency of the antenna also reflect the performance that can be expected in an end-solution. Note that efficiency data is provided before application of a matching network to facilitate comparison.

In addition to simply reviewing charts of VSWR, gain and efficiency, it may also be valuable to calculate the total radiated efficiency (TRE) of the antenna at important frequencies. By reviewing individual parameters and TRE, a more complete comparison of likely performance can be achieved.

The SP610 Antenna Evaluation Kit (AEK-SP610) PCB shown in Figure 2 displays the ground plane size for the evaluation board as well as the smaller ground plane sizes addressed in this application note.

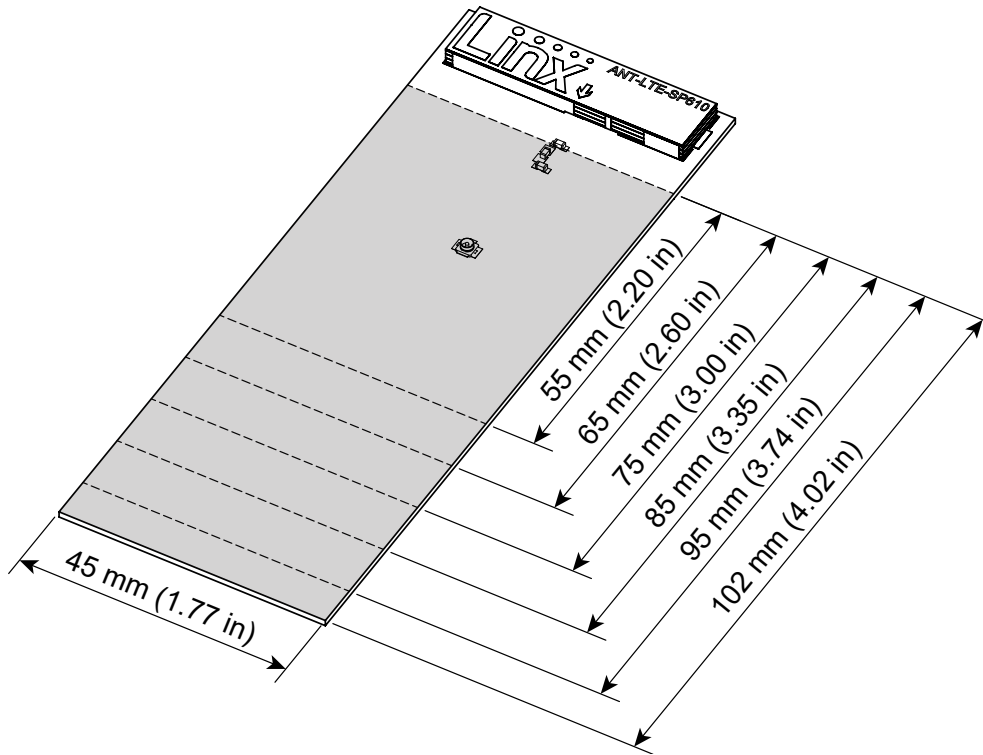

Figure 2. SP610 Evaluation PCB with Dimensions for Various Size Ground Planes

120 mm x 45 mm Ground Plane

Linx understands that designers desire a compact solution when working with the SP610 which is why the standard data provided is for a 102 mm long ground plane. However, other chip antenna offerings tend to supply data for a larger ground plane of 120 mm to 130 mm in length which naturally “enhances” performance data. To enable a more even comparison, SP610 simulated performance data on a 120 mm long ground plane is provided in Figure 3 through Figure 5.

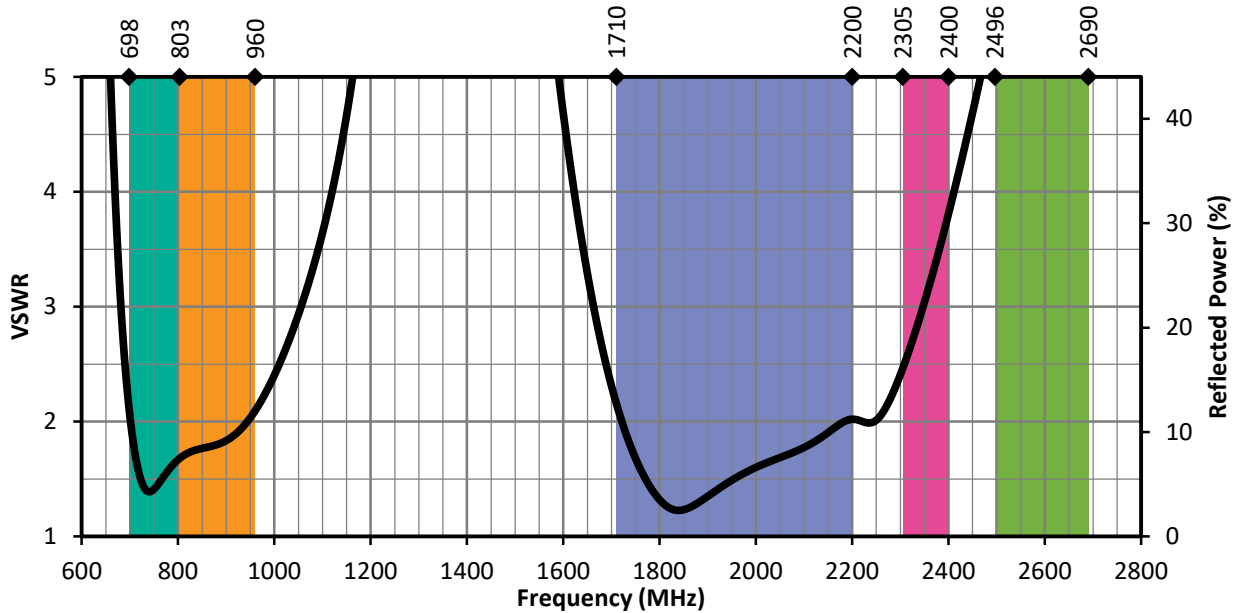

Figure 3. SP610 Simulated Performance on a 120 mm x 45 mm Ground Plane

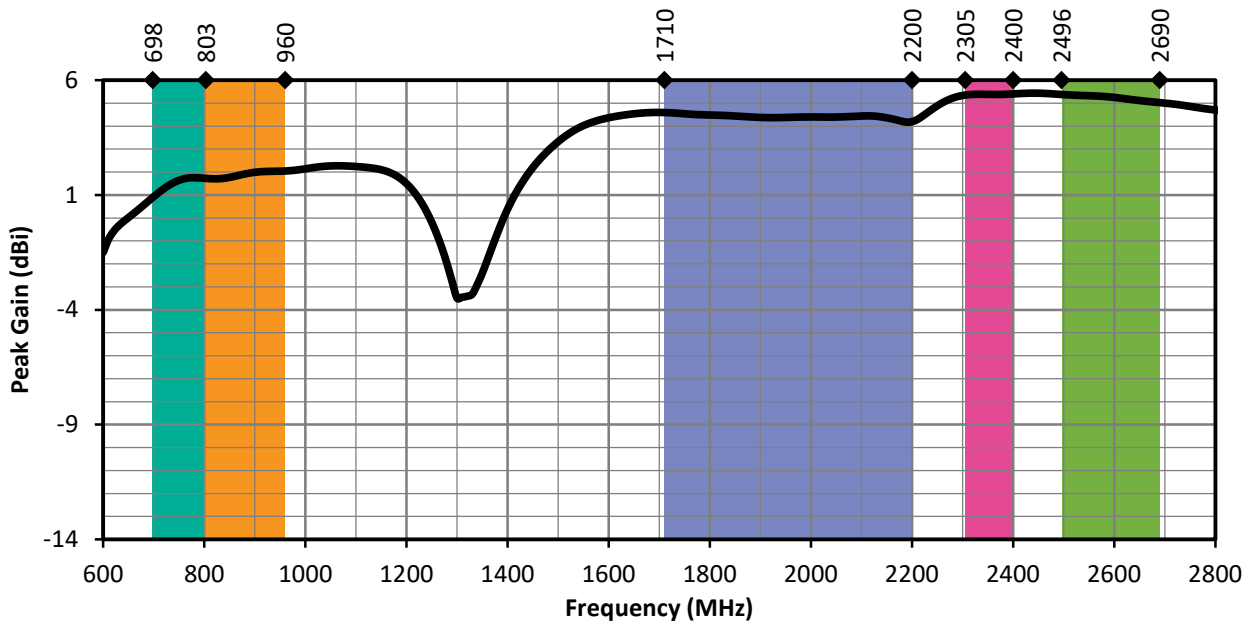

Figure 4. SP610 Simulated Peak Gain on a 120 mm x 45 mm Ground Plane

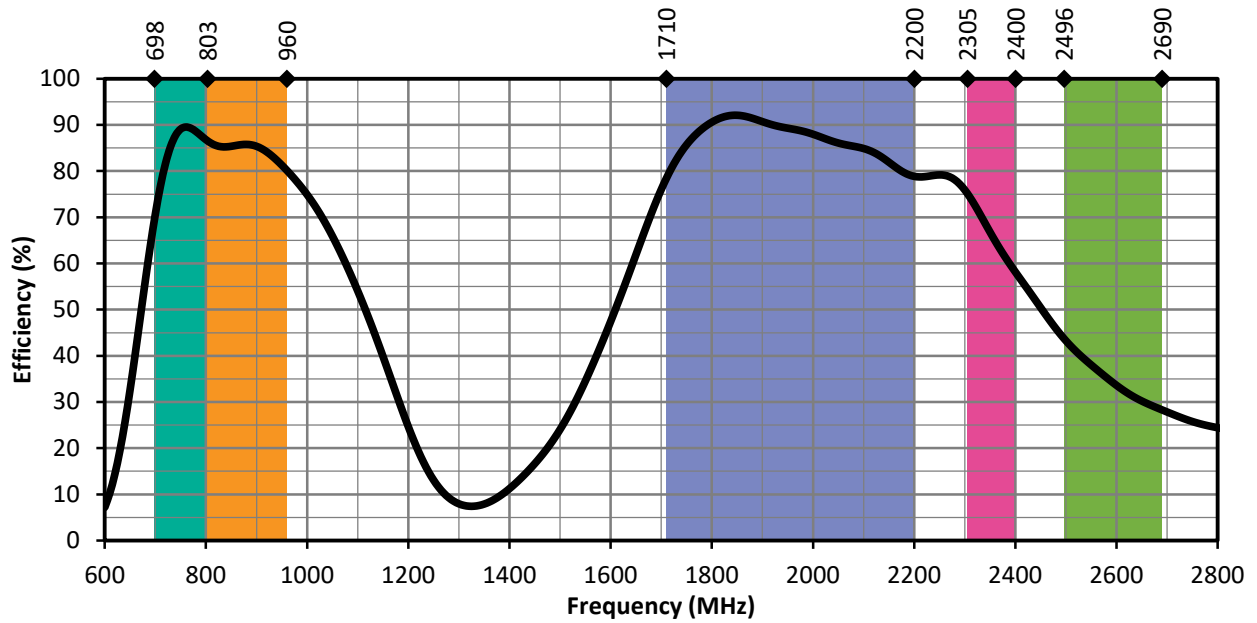

Figure 5. SP610 Simulated Radiation Efficiency on a 120 mm x 45 mm Ground Plane

102 mm x 45 mm Ground Plane

The 102 mm x 45 mm ground plane is the recommended minimum size for the SP610 and is the size used for the SP610 evaluation board (Linx p/n AEK-SP610). Performance data for this ground plane is measured data (see Figure 6 through Figure 8) and is also available in the SP610 datasheet.

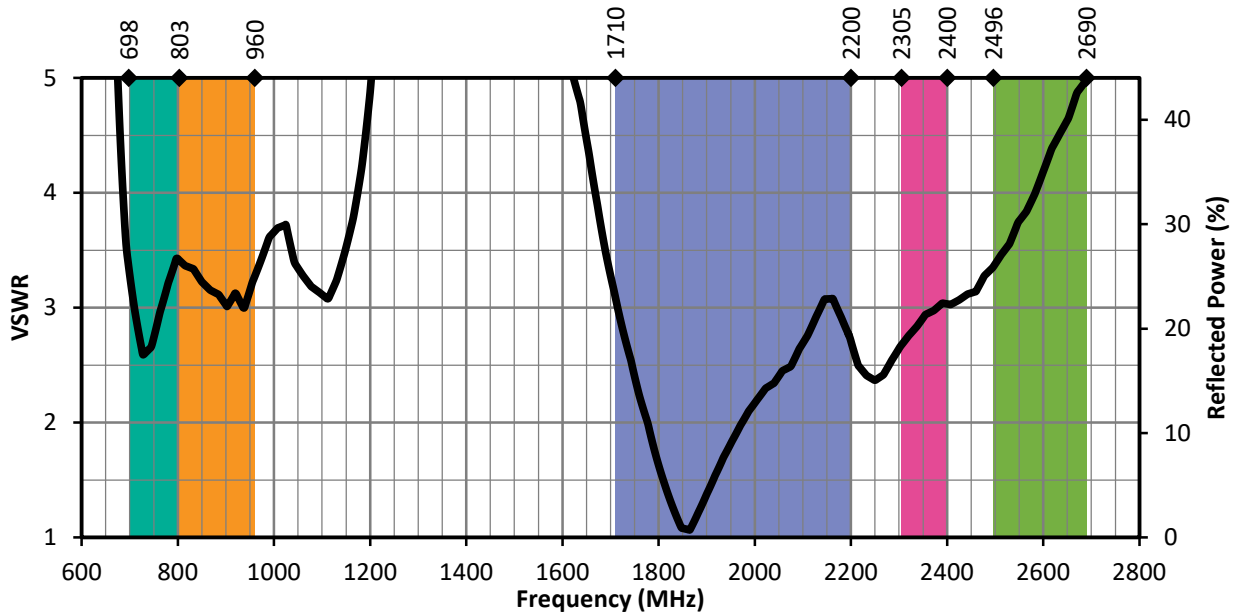

Figure 6. SP610 Measured Performance on a 102 mm x 45 mm Ground Plane

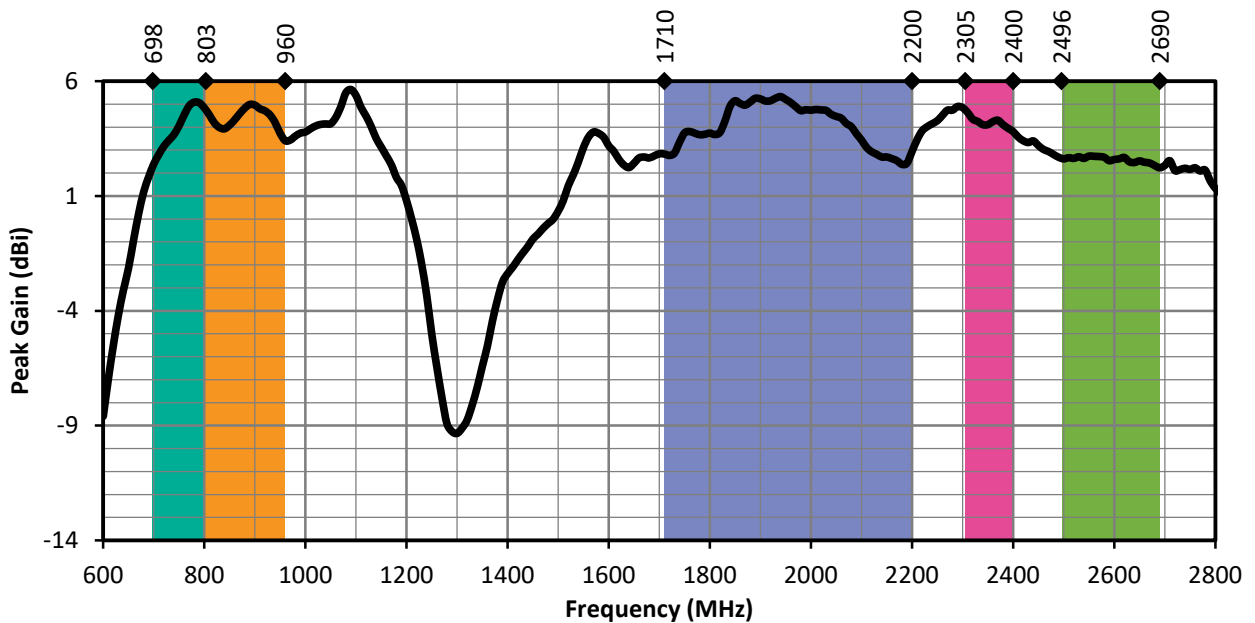

Figure 7. SP610 Measured Peak Gain on a 102 mm x 45 mm Ground Plane

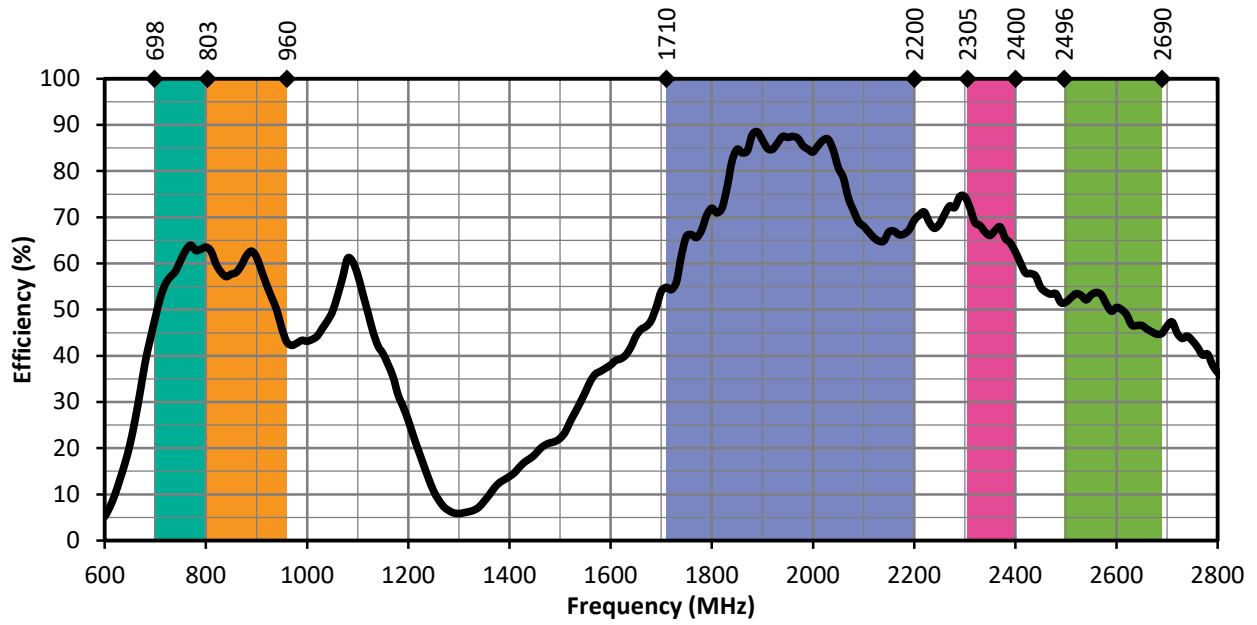

Figure 8. SP610 Measured Radiation Efficiency on a 102 mm x 45 mm Ground Plane

95 mm x 45 mm Ground Plane

The SP610 exhibits strong simulated performance on a 95 mm x 45 mm ground plane as shown in Figure 9 through Figure 11. Therefore, no matching component recommendations are provided.

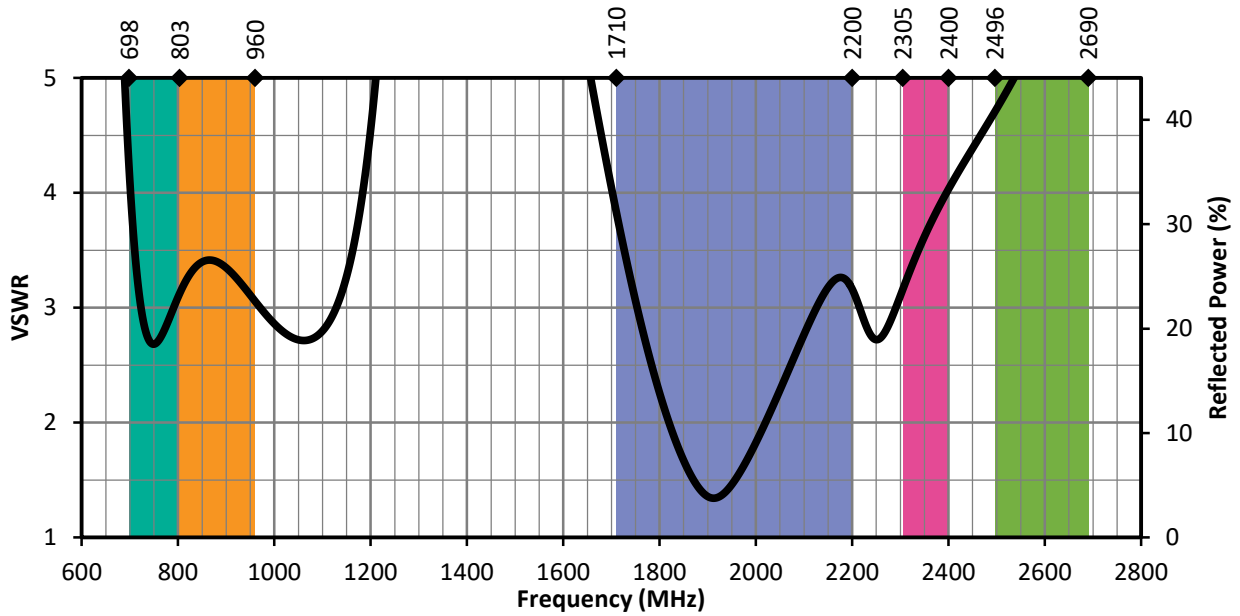

Figure 9. SP610 Simulated Performance on a 95 mm x 45 mm Ground Plane

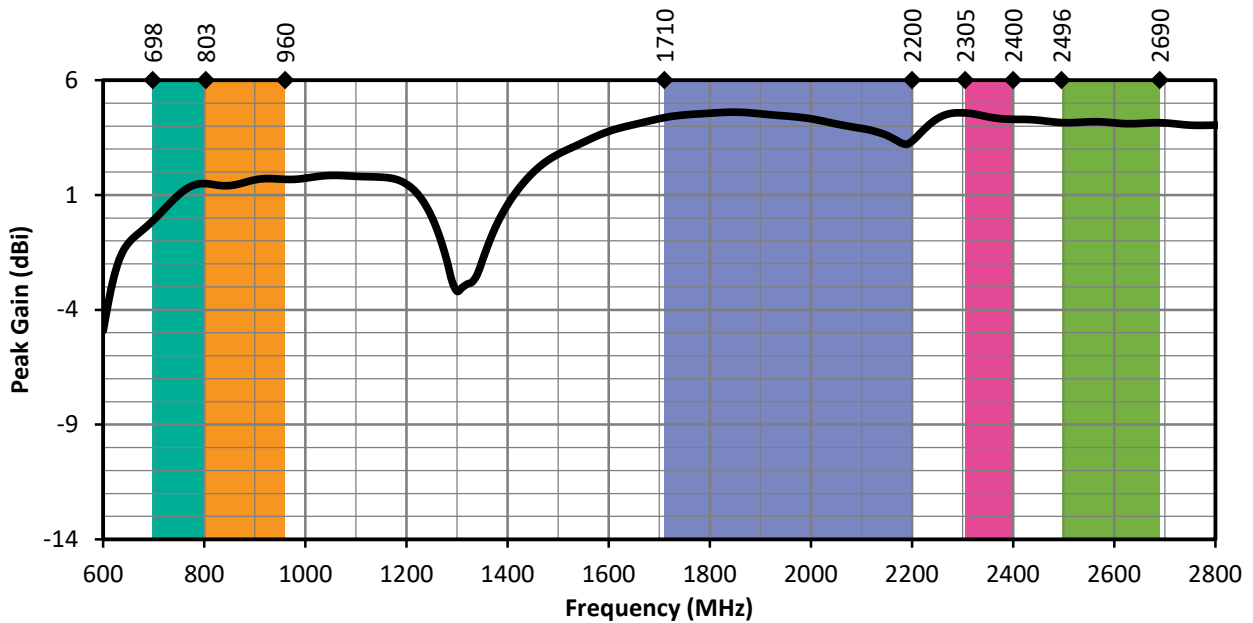

Figure 10. SP610 Simulated Peak Gain on a 95 mm x 45 mm Ground Plane

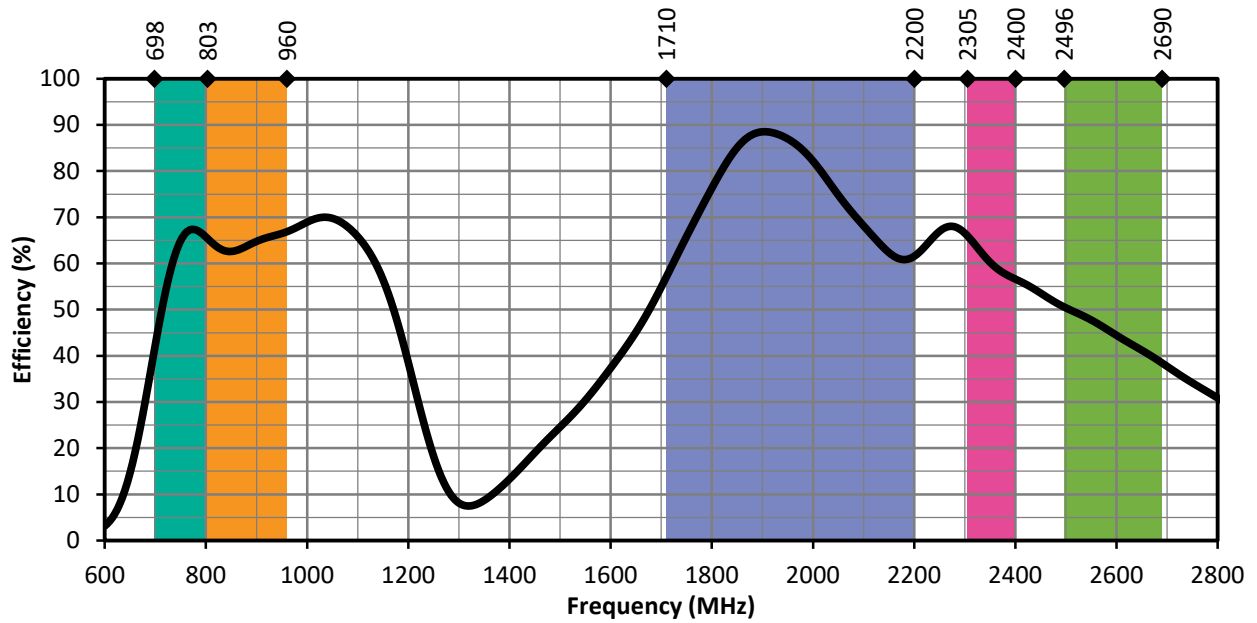

Figure 11. SP610 Simulated Radiation Efficiency on a 95 mm x 45 mm Ground Plane



85 mm x 45 mm Ground Plane

Simulated performance for the SP610 on an 85 mm x 45 mm ground plane is shown in Figure 12 through Figure 14. An 85 mm ground plane is very close to the guided wavelength limitation to support the lowest frequency bands of the SP610, and a 4-element matching network is recommended. The suggested starting matching circuit and component values are provided in Table 1.

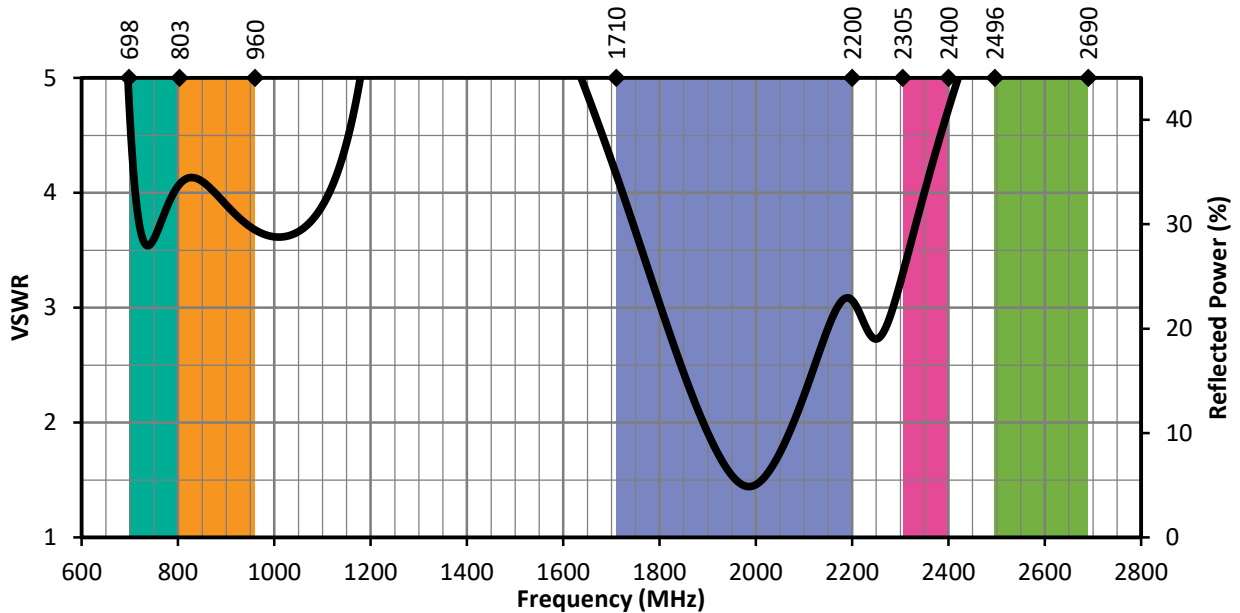

Figure 12. SP610 Simulated Performance on an 85 mm x 45 mm Ground Plane

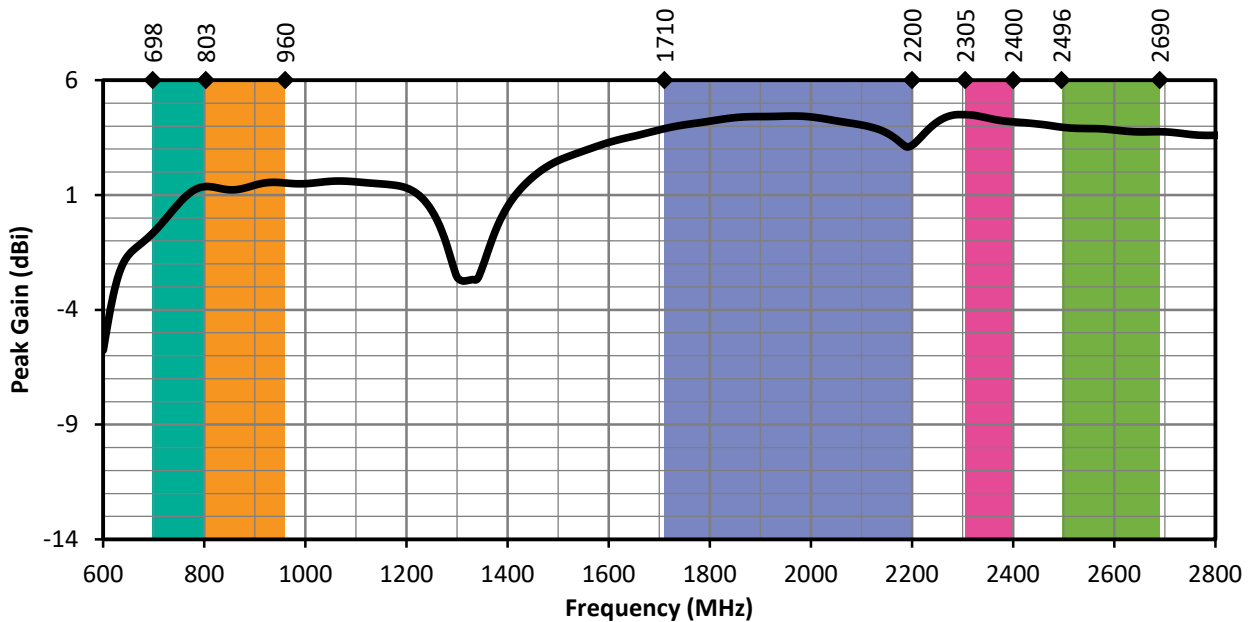

Figure 13. SP610 Simulated Peak Gain on an 85 mm x 45 mm Ground Plane

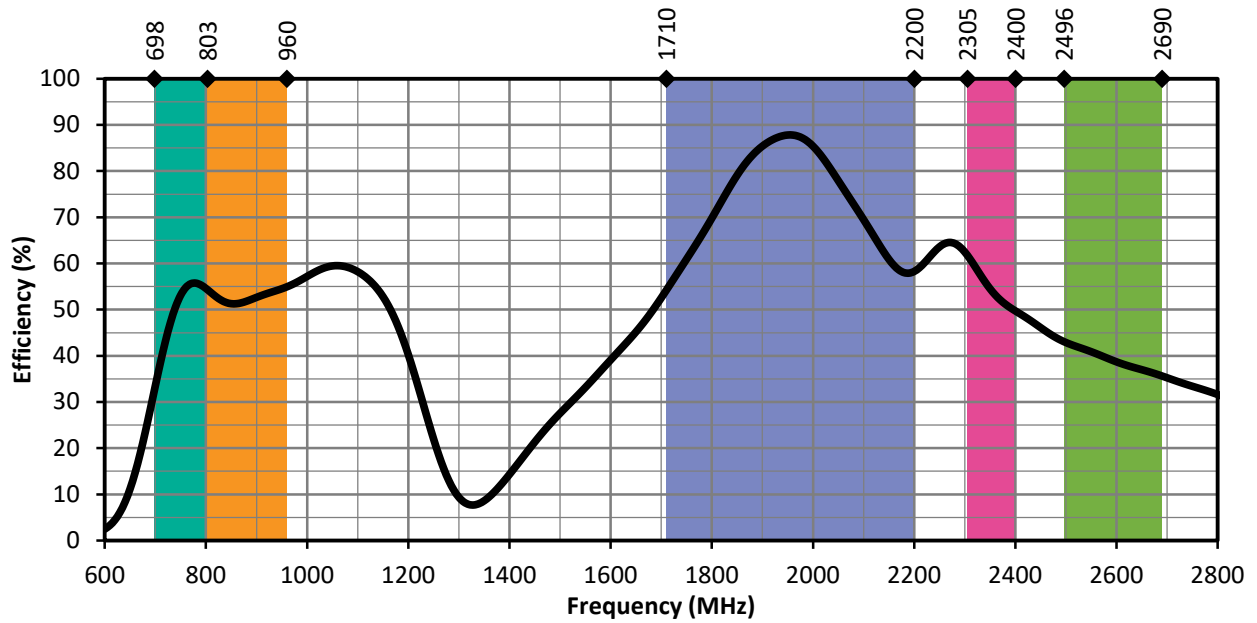

Figure 14. SP610 Simulated Radiation Efficiency on an 85 mm x 45 mm Ground Plane

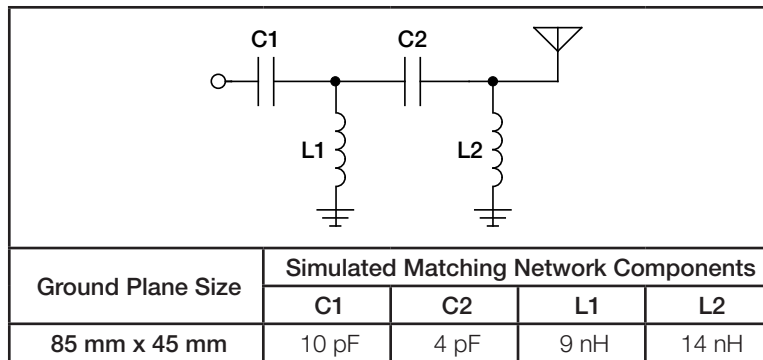

Table 1. Suggested Starting Matching Circuit Values for an 85 mm x 45 mm Ground Plane

75 mm x 45 mm Ground Plane

Simulated performance for the SP610 on a 75 mm x 45 mm ground plane is shown in Figure 15 through Figure 17. A 75 mm ground plane is shorter than required to maintain the proper guided wavelength dimension and performance will be affected at lower frequencies. A 4-element matching network is required. The suggested starting matching circuit and component values are provided in Table 2.

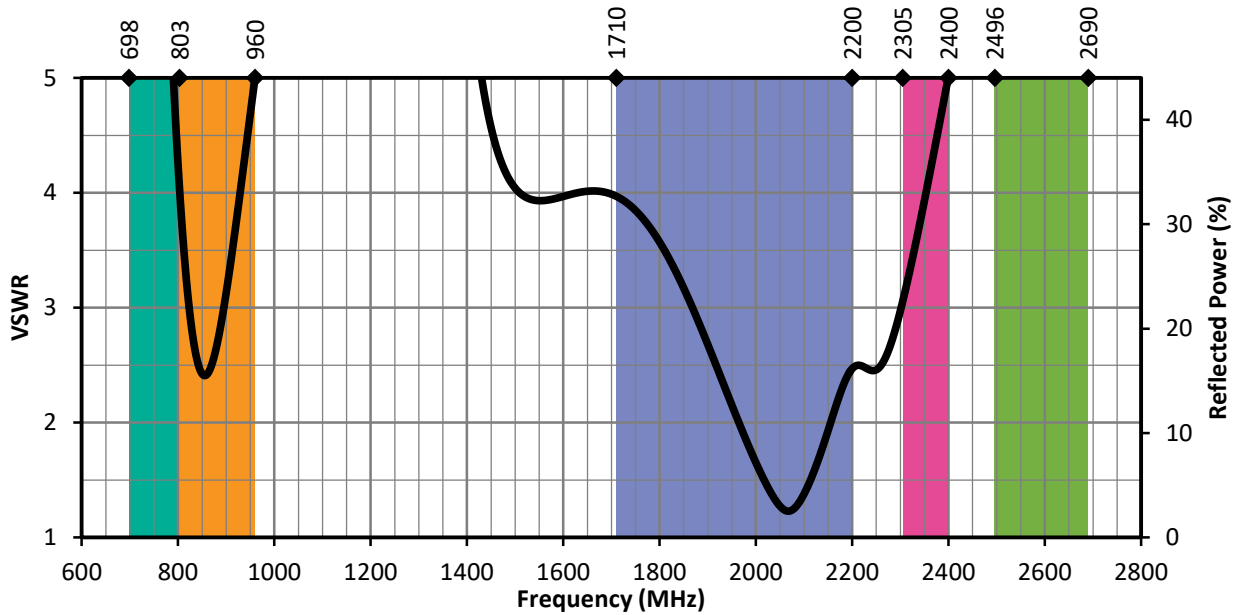

Figure 15. SP610 Simulated Performance on a 75 mm x 45 mm Ground Plane

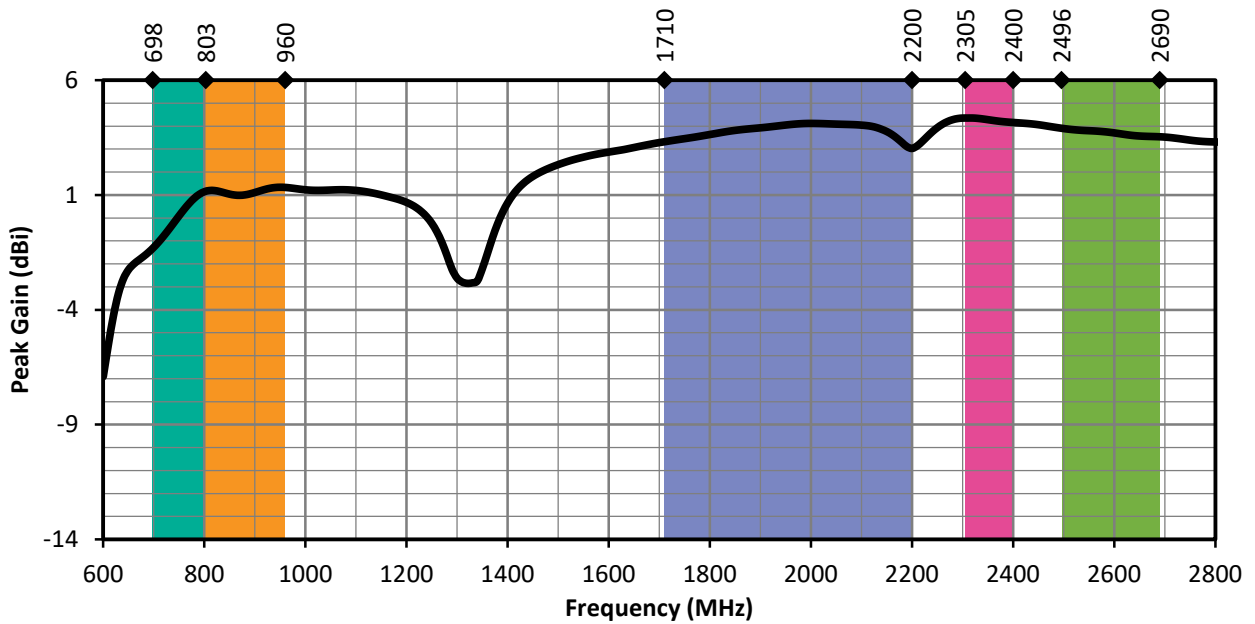

Figure 16. SP610 Simulated Peak Gain on a 75 mm x 45 mm Ground Plane

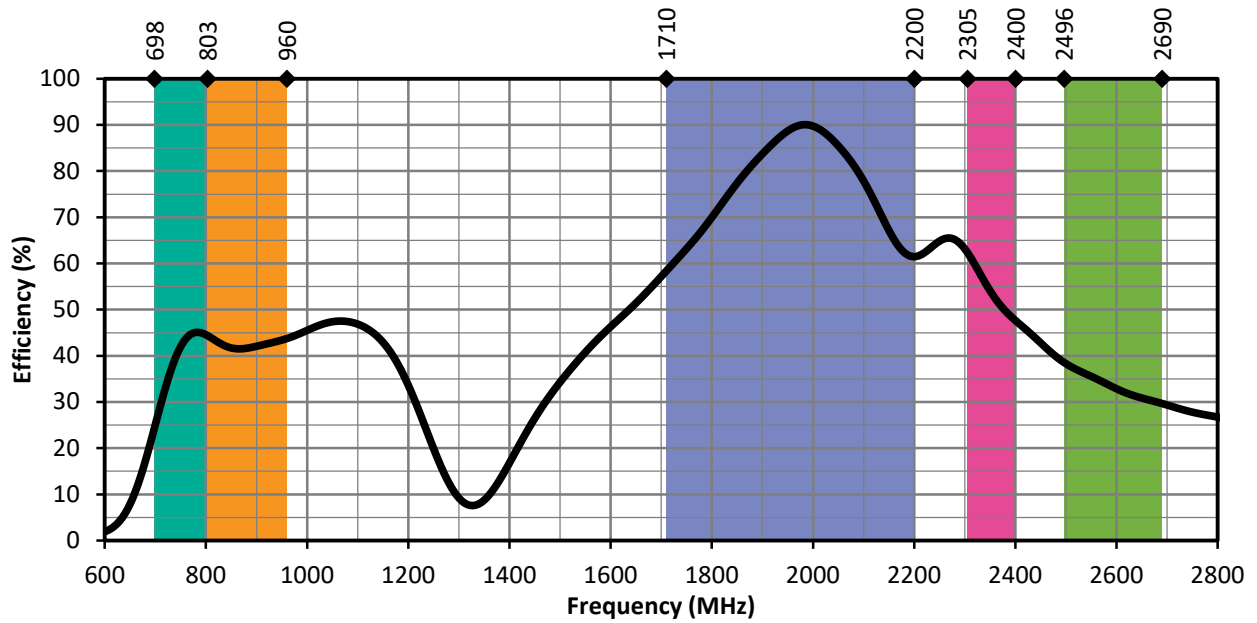

Figure 17. SP610 Simulated Radiation Efficiency on a 75 mm x 45 mm Ground Plane

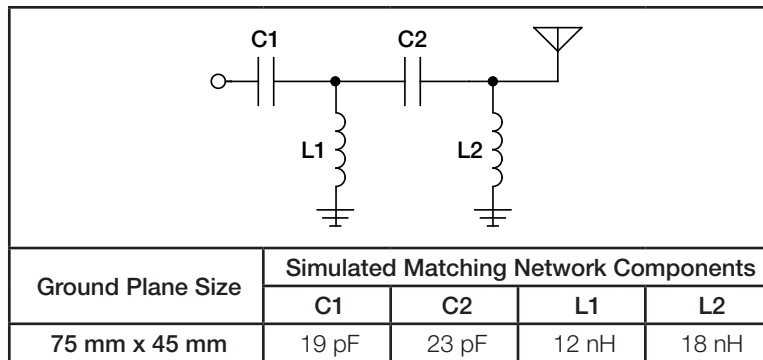

Table 2. Suggested Starting Matching Circuit Values for a 75 mm x 45 mm Ground Plane

65 mm x 45 mm Ground Plane

Simulated performance for the SP610 on a 65 mm x 45 mm ground plane is shown in Figure 18 through Figure 20. A 65 mm ground plane is shorter than required to maintain the proper guided wavelength dimension and performance will be affected at lower frequencies. A 4-element matching network is required. The suggested starting matching circuit and component values are provided in Table 3.

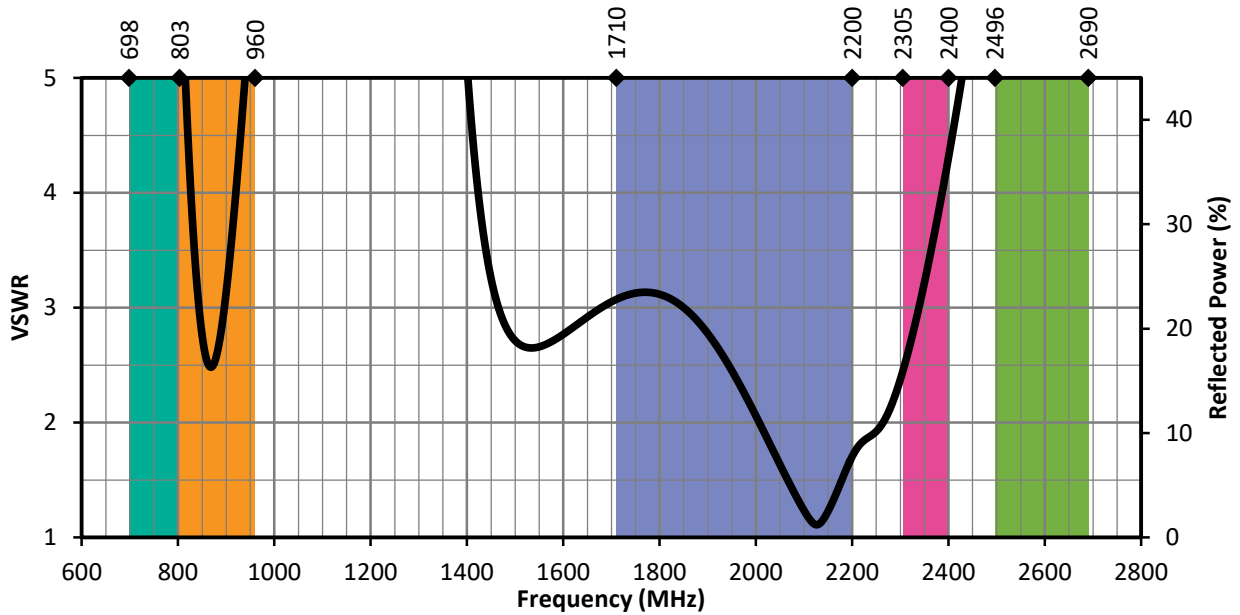

Figure 18. SP610 Simulated Performance on a 65 mm x 45 mm Ground Plane

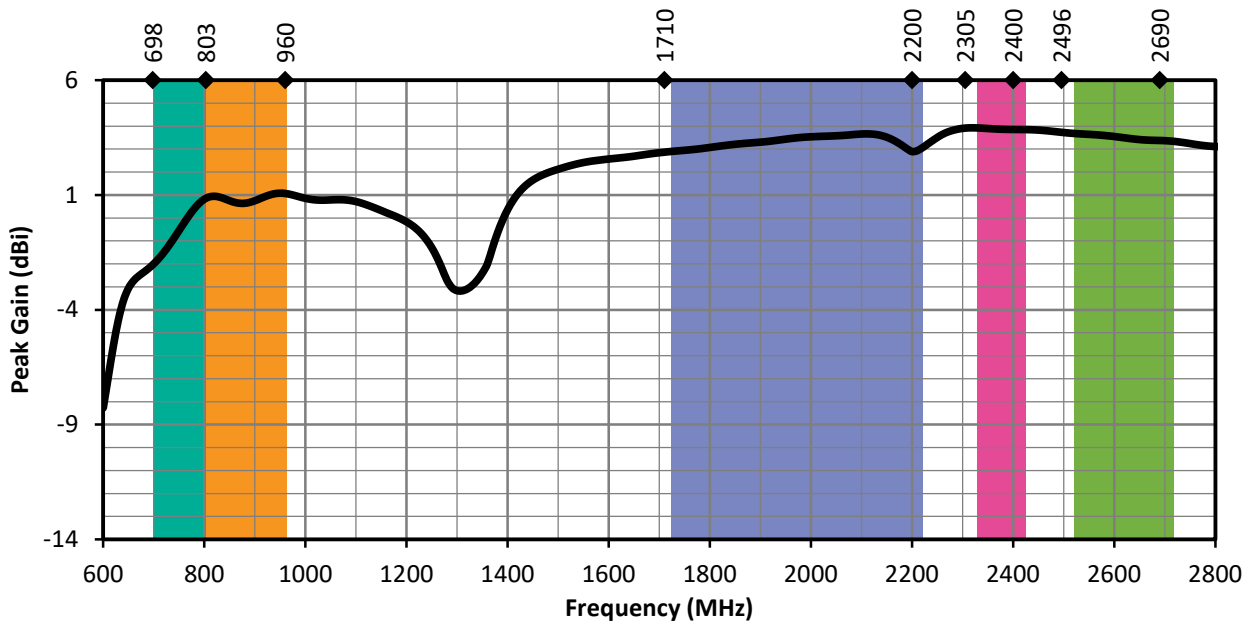

Figure 19. SP610 Simulated Peak Gain on a 65 mm x 45 mm Ground Plane

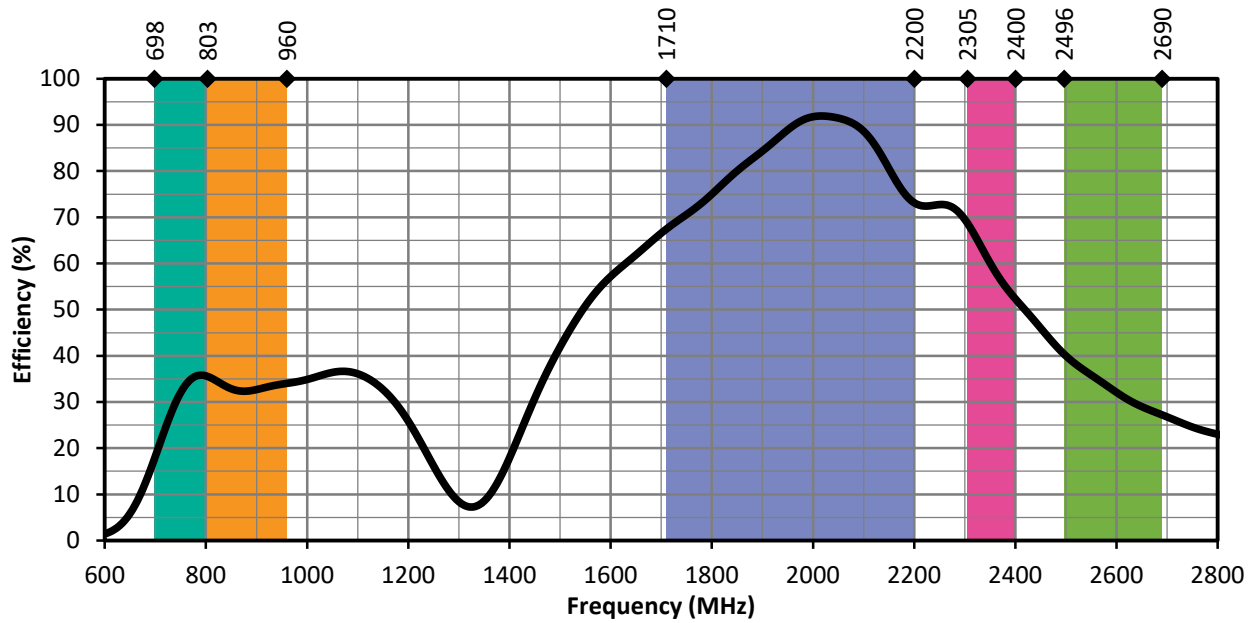

Figure 20. SP610 Simulated Radiation Efficiency on a 65 mm x 45 mm Ground Plane

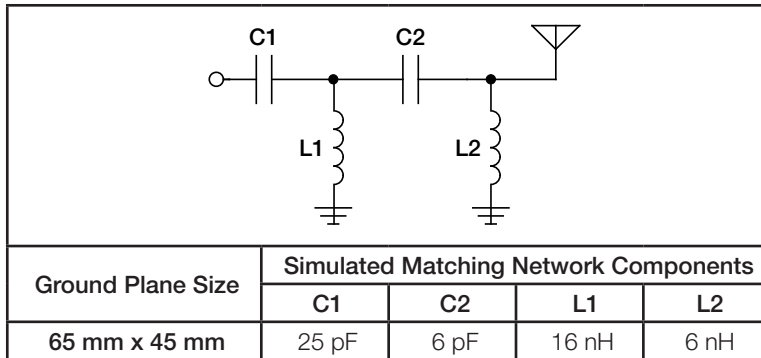

Table 3. Suggested Starting Matching Circuit Values for a 65 mm x 45 mm Ground Plane

55 mm x 45 mm Ground Plane

Simulated performance for the SP610 on a 55 mm x 45 mm ground plane is shown in Figure 21 through Figure 23. A 55 mm ground plane is shorter than required to maintain the proper guided wavelength dimension and performance will be affected at lower frequencies. A 4-element matching network is required. The suggested starting matching circuit and component values are provided in Table 4.

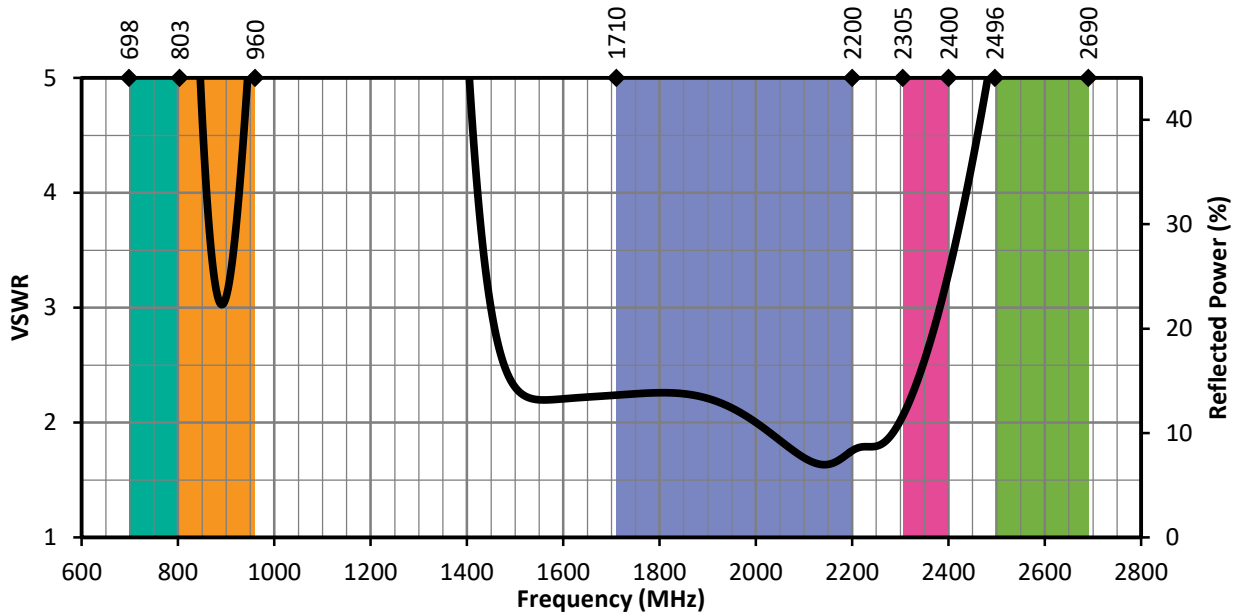

Figure 21. SP610 Simulated Performance on a 55 mm x 45 mm Ground Plane

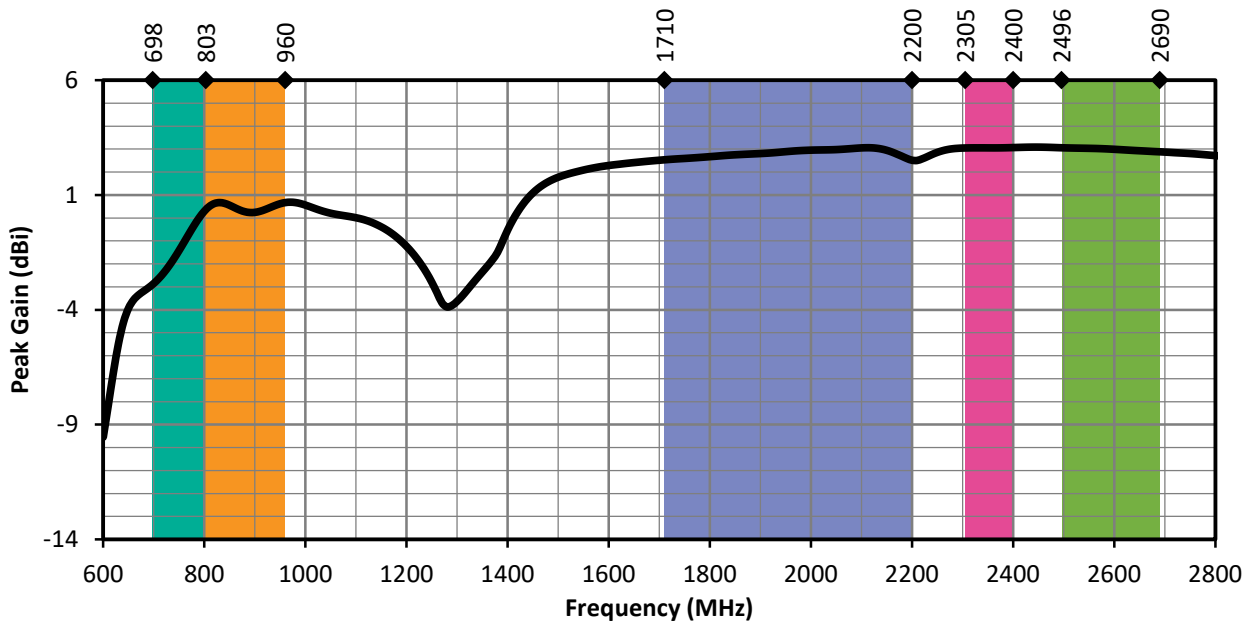

Figure 22. SP610 Simulated Peak Gain on a 55 mm x 45 mm Ground Plane

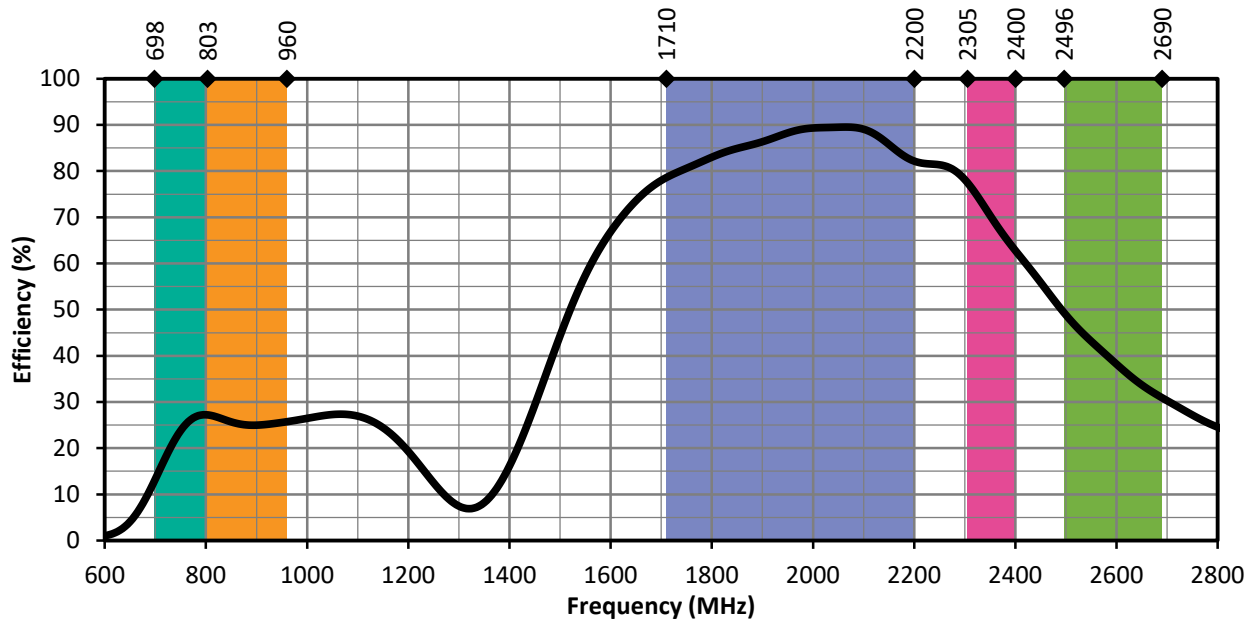

Figure 23. SP610 Simulated Radiation Efficiency on a 55 mm x 45 mm Ground Plane

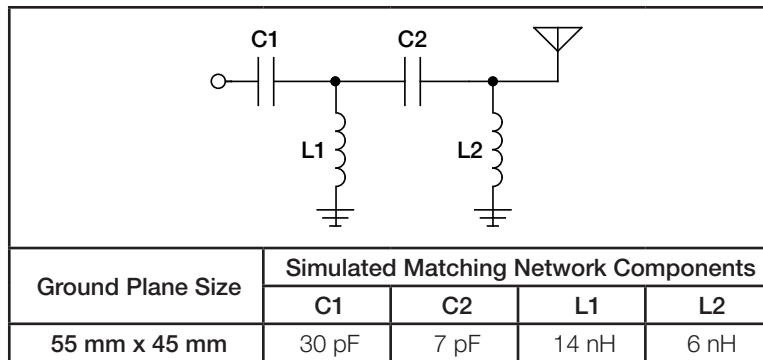

Table 4. Suggested Starting Matching Circuit Values for a 55 mm x 45 mm Ground Plane



## Antenna Definitions and Useful Formulas

**VSWR** - Voltage Standing Wave Ratio. VSWR is a unitless ratio that describes the power reflected from the antenna back to the radio. A lower VSWR value indicates better antenna performance at a given frequency. VSWR is easily derived from Return Loss.

$$\text{VSWR} = \frac{10^{\left[\frac{\text{Return Loss}}{20}\right]} + 1}{10^{\left[\frac{\text{Return Loss}}{20}\right]} - 1}$$

**Return Loss** - Return loss represents the loss in power at the antenna due to reflected signals, measured in decibels. A lower return loss value indicates better antenna performance at a given frequency. Return Loss is easily derived from VSWR.

$$\text{Return Loss} = -20 \log_{10} \left[ \frac{\text{VSWR} - 1}{\text{VSWR} + 1} \right]$$

**Efficiency ( $\eta$ )** - The total power radiated from an antenna divided by the input power at the feed point of the antenna as a percentage.

**Total Radiated Efficiency** - (TRE) The total efficiency of an antenna solution comprising the radiation efficiency of the antenna and the transmitted (forward) efficiency from the transmitter.

$$\text{TRE} = \eta \cdot \left( 1 - \left( \frac{\text{VSWR} - 1}{\text{VSWR} + 1} \right)^2 \right)$$

**Gain** - The ratio of an antenna's efficiency in a given direction (G) to the power produced by a theoretical lossless (100% efficient) isotropic antenna. The gain of an antenna is almost always expressed in decibels.

$$G_{\text{db}} = 10 \log_{10}(G)$$

$$G_{\text{dBd}} = G_{\text{dBi}} - 2.51\text{dB}$$

**Peak Gain** - The highest antenna gain across all directions for a given frequency range. A directional antenna will have a very high peak gain compared to average gain.

**Average Gain** - The average gain across all directions for a given frequency range.

**Maximum Power** - The maximum signal power which may be applied to an antenna feed point, typically measured in watts (W).

**Reflected Power** - A portion of the forward power reflected back toward the amplifier due to a mismatch at the antenna port.

$$\left( \frac{\text{VSWR} - 1}{\text{VSWR} + 1} \right)^2$$

**decibel (dB)** - A logarithmic unit of measure of the power of an electrical signal.

**decibel isotropic (dBi)** - A comparative measure in decibels between an antenna under test and an isotropic radiator.

**decibel relative to a dipole (dBd)** - A comparative measure in decibels between an antenna under test and an ideal half-wave dipole.

**Dipole** - An ideal dipole comprises a straight electrical conductor measuring 1/2 wavelength from end to end connected at the center to a feed point for the radio.

**Isotropic Radiator** - A theoretical antenna which radiates energy equally in all directions as a perfect sphere.

**Omnidirectional** - Term describing an antenna radiation pattern that is uniform in all directions. An isotropic antenna is the theoretical perfect omnidirectional antenna. An ideal dipole antenna has a donut-shaped radiation pattern and other practical antenna implementations will have less perfect but generally omnidirectional radiation patterns which are typically plotted on three axes.

---

**Website:** <http://linxtechnologies.com>  
**Linx Offices:** 159 Ort Lane, Merlin, OR, US 97532  
**Phone:** +1 (541) 471-6256  
**E-MAIL:** [info@linxtechnologies.com](mailto:info@linxtechnologies.com)

---

Linx Technologies reserves the right to make changes to the product(s) or information contained herein without notice. No liability is assumed as a result of their use or application. No rights under any patent accompany the sale of any such product(s) or information.

Wireless Made Simple, and Splatch are registered trademarks of Linx Acquisitions LLC. Other product and brand names may be trademarks or registered trademarks of their respective owners.

Copyright © 2019 Linx Technologies

All Rights Reserved

Doc # AN19256-04ANT (Replaces Doc # AN19233-04ANT)

